



List Of Content - Component List

(Alphabetical Within Category)

Accessories

Articulating Arm	17 - 18
Articulating Arm & tray	17
Balancers, Tool	16
Bench Top Riser - Metal	3
Bin Track	17
Bin Track, With Swinging Arm	17
Bins, ESD, Plastic	20
Bins, Plastic	20
Board, Magnet	22
Board, Peg Board	22
Board, Privacy	22
Board, Tools	23
Cabinet, Metal	22
Cabinets, Laminated	21
Cable Management	20
Casters	10
CPU Holder	20
Dimmable Lighting	24
Document Holder	18
Drawer Units	21
Drawer, Heavy Duty	22
Drawer, Keyboard	19
Drawer, Pencil	19
Drawers, Metal	21
Drawers, Stackable	22
Duo Lights	24
Electric Outlet Strips	20
ESD Bins	20
ESD Lighting	24
Fixtures, Lighting	24
Heavy Duty Drawer	22
Holder CPU	20
Hooks For Tool Board	23
Keyboard Trays	19
Keyboard Drawer	19
Key-lock Drawers	21
Kits For Mounting Top To Leg	9 - 10
Laminated Cabinets	21
Light Fixture Support Track	15
Light Fixtures	24
Lighting, ESD	24
Lockable Drawers	21
Louvered Panel	17
Magnet Board	22

Accessories- Cont.

Metal Cabinets	22
Metal Drawers	21
Middle Post Support	14
Monitor Arms	18
Mouse Pad & Keyboard Drawer	19
Outlets, Electric	20
Overhead Light Fixtures	24
Overhead Support Track Kit	15
Panel, Louvered	17
Parabol Light Fixtures	24
Peg Board	22
Plastic Bins	20
Post Support Track	14
Posts	14
Privacy Board	22
Quad-Posts	14
Raised Edge	3
Shelf, Key board	19
Shelving, For Bench	3-4, 11-12
Side & Back Stop Sets, For Top	3
Stackable Drawers	22
Support Arm - Heave Duty	15
Support Arm - Light Duty	15
Swinging Arm	17, 18
Swinging Arm with Bin Track	17
Swinging Arm with Tray	17
Tool Balancers	16
Tool board	23
Tool Hooks	23
Tool Trolley	16
Tops	1 - 3
Track for Light Fixture	15
Track for Tool Trolley	15
Track, for Plastic Bins	17
Tray, on Swinging Arm	17
Tray, Slide Out From Under Top	19
Uprights, Vertical	14
Vertical Uprights & Posts	14
Zero-Gravity tool balancer	16

Boards: Magnet, Peg, Privacy

22

Casters

10

Drawers & Cabinets

Cabinet, metal	22
Cabinets, Laminated	21
Drawer Units	21
Drawer, heavy duty	22
Drawers, Metal	21
Drawers, stackable	22
Heavy Duty drawer	22
Key lock drawers	21
Laminated cabinets	21
Lockable drawers	21
Metal Cabinets	22
Metal Drawers	21
Stackable drawers	22

Kit For Bench Tops

9 - 10

Leg Supports

Manual - Mechanical Adjustable	6 - 9
Motorized	5 - 9
Hand Crank	6 - 8
Mechanically adjustable	6 - 7
E600 Leg Supports	5
Cantilever leg supports	5 - 9
Four Post leg supports	6 - 7
Three leg benches	6 - 9
Four leg benches	5
Aluminum Leg Supports	5
H-Leg supports	6 - 7
L-Leg supports	7 - 9
Casters	10
Electric Bench	5 - 9

Light Fixtures

Duo lights	24
Parabol light fixtures	24
ESD Lighting	24
Dimmable Lighting	24

Shelving

Angle Adjustable Shelving	11, 12
Bench Top Riser - Metal	1
Carton Hoops for shelf	12
E600 shelving	13
Hoops for shelf	12
Kits for mounting top to leg supports	9 - 10
Laminate Shelving	11
Lower Shelf	12
Metal Shelving	12
Shelf Edging	3, 11
Shelf for Under the Top	12
Shelving - Angle Adjustable	11 - 12
Shelving - Laminate	11

Shelving - Cont.

Shelving - Metal	12
Side shelves for E600	13
Tilt Shelving	11 - 12

Tops

3MM Euro Edge Top - Laminate	1
Bench Top Kits	9 - 10
Center Piece tilt	4
Custom Table Tops	4
ESD Post Formed Top - Laminate	1
Euro Edge Top	1
Hand Crank Tilt Top	4, 10
HDPE Top	4
Laboratory Tops	4
Laminate Tops	1
Manual Tilt Top	4, 10
Maple Top	2
Metal Top	2
Motorized Tilt Top	4, 10
Pneumatic Pop-Up Ball Tops	4
Post Formed Front Edge- Laminate	1
Powder Coated Sheet Metal Tops	2
Recessed Tops	4
Roller Ball Tops	4
Sheet Metal Top - Powder coated Top	2
Stainless Steel Top	2
Tilt Top - Center Piece	4, 10
UHMW Top	4
Whole top tilt	4, 10

Top Accessories

Bench Top Kits	9 - 10
Bench Top Riser - Metal	3
Edges, raised	3
Raised Edge - 2 Inch	3
Raised Edge - 3 Inch	3
Side & Back Stop Sets	3

Vertical Uprights & Posts

14

Overhead Support Arms & Tracks

Support Arm - Heavy Duty	15
Support Arm - Light Duty	15
Track for Tool Trolley	15
Overhead Support Track Kit	15
Tool Trolley	16
Tool Balancers	16

Tool Trolley & Tool Balancers

Tool Trolley	16
Tool Balancers, Zero-Gravity	16
Retractor Type Tool Balancer	16

Post Formed Front Edge Top - Laminate

Top Length [In]	Top Thickness [In]	Top Depth: 30" Item#	Top Depth: 36" Item#
36	1 1/4	TP3036P	TP3636P
48	1 1/4	TP3048P	TP3648P
60	1 1/4	TP3060P	TP3660P
72	1 1/4	TP3072P	TP3672P
84	1 1/4	TP3084P	TP3684P
96	1 1/4	TP3096P	TP3696P

Other sizes, dimensions and colors are also available.

Our most common bench top with a durable surface of a "Formica" type industrial grade laminate with a rounded, 180° post formed "bull nose", front edge. All other edges square. Core of high density particle board and a backer sheet (no exposed wood). Laminated edges. Almond is the standard color.

For standard GREY color replace letter "P" in item number with letter "G".

ESD Post Formed Front Edge Top - Laminate

Top Length [In]	Top Thickness [In]	Top Depth: 30" Item#	Top Depth: 36" Item#
36	1 1/4	TP3036PE	TP3636PE
48	1 1/4	TP3048PE	TP3648PE
60	1 1/4	TP3060PE	TP3660PE
72	1 1/4	TP3072PE	TP3672PE
84	1 1/4	TP3084PE	TP3684PE
96	1 1/4	TP3096PE	TP3696PE

Other sizes, dimensions and colors are also available.

Same as our standard top but with semi-conductive ESD laminate. Top has a rounded, 180° post formed "bull nose", front edge. All other edges square. Core of high density particle board and a backer sheet (no exposed wood). Laminated edges. Almond is the standard color. Includes ESD grounding kit.

For standard GREY color replace letter "P" in item number with letter "G".

3MM Euro Edge Top - Laminate

Top Length [In]	Top Thickness [In]	Top Depth: 30" Item#	Top Depth: 36" Item#
36	1 1/4	TP3036R	TP3636R
48	1 1/4	TP3048R	TP3648R
60	1 1/4	TP3060R	TP3660R
72	1 1/4	TP3072R	TP3672R
84	1 1/4	TP3084R	TP3684R
96	1 1/4	TP3096R	TP3696R

Other sizes, dimensions and colors are also available.

The 3MM thick plastic edges are extremely durable and this top is built to last. Surface of a "Formica" type industrial grade laminate. All edges are square with an ergonomic "soft" round radius. Core of high density particle board and backer sheet (no exposed wood). Almond is the standard color.

For standard GREY color replace letter "P" in item number with letter "G".

ESD 3MM Euro Edge Top - Laminate

Top Length [In]	Top Thickness [In]	Top Depth: 30" Item#	Top Depth: 36" Item#
36	1 1/4	TP3036RE	TP3636RE
48	1 1/4	TP3048RE	TP3648RE
60	1 1/4	TP3060RE	TP3660RE
72	1 1/4	TP3072RE	TP3672RE
84	1 1/4	TP3084RE	TP3684RE
96	1 1/4	TP3096RE	TP3696RE

Other sizes, dimensions and colors are also available.

The 3MM thick plastic edges are extremely durable and this top is built to last. Surface of a semi conductive ESD industrial grade laminate. All edges are square with an ergonomic "soft" round radius. Core of high density particle board and backer sheet (no exposed wood). Almond is the standard color.

For standard GREY color replace letter "P" in item number with letter "G".

Sheet Metal Bench Top - Powder coated Top

Top Length [In]	Top Thickness [In]	Top Depth: 30" Item#	Top Depth: 36" Item#
36	1 1/4	TP3036M	TP3636M
48	1 1/4	TP3048M	TP3648M
60	1 1/4	TP3060M	TP3660M
72	1 1/4	TP3072M	TP3672M
96	1 1/4	TP3096M	TP3696M

Other sizes, dimensions, gauges and colors are also available.

Our sheet metal bench top has "soft" round welded corners. The 1" thick particle board core makes it very solid and less noisy than other tops without a core. 16 gauge steel. Optional powder coated (putty orange peel surface) or bare metal.

Sheet Metal Bench Top - Bare Metal

Top Length [In]	Top Thickness [In]	Top Depth: 30" Item#	Top Depth: 36" Item#
36	1 1/4	TP3036MB	TP3636MB
48	1 1/4	TP3048MB	TP3648MB
60	1 1/4	TP3060MB	TP3660MB
72	1 1/4	TP3072MB	TP3672MB
96	1 1/4	TP3096MB	TP3696MB

Other sizes, dimensions, gauges and colors are also available.

Our sheet metal bench top has "soft" round welded corners. The 1" thick particle board core makes it very solid and less noisy than other tops without a core. 16 gauge steel. Optional powder coated (putty orange peel surface) or bare metal.

Stainless Steel Top

Top Length [In]	Top Thickness [In]	Top Depth: 30" Item#	Top Depth: 36" Item#
36	1 1/4	T3036S	T3636S
48	1 1/4	T3048S	T3648S
60	1 1/4	T3060S	T3660S
72	1 1/4	T3072S	T3672S
96	1 1/4	T3096S	T3696S

Other sizes, dimensions and gauges are also available.

Our stainless steel metal bench top has "soft" rounded welded corners. The 1" thick particle board core makes it very solid and less noisy than other tops without a core. 16 gauge steel.

Maple Top

Top Length [In]	Top Thickness [In]	Top Depth: 30" Item#	Top Depth: 36" Item#
48	1 1/4	T3048S	T3648S
60	1 1/4	T3060S	T3660S
72	1 1/4	T3072S	T3672S
96	1 1/4	T3096S	T3696S

Other sizes, dimensions and thickness are also available.

Quick Facts:

- 3/8 "soft edge" radius as std.
- 180° Bullnose is optional
- 1 3/4 thick also available
- We customize any top!

Our Maple tops are face glued maple sanded to a smooth surface and sealed with a two-coat catalyzed varnished finished.

Side & Back Stop Sets

Width [In]	Depth [In]	Item#
36	24	BS2436
48	24	BS2448
60	24	BS2460
72	24	BS2472
36	30	BS3036
48	30	BS3048
60	30	BS3060
72	30	BS3072
96	30	BS3096
36	36	BS3636
48	36	BS3648
60	36	BS3660
72	36	BS3672
84	36	BS3696
96	36	BS36120
108	36	BS36144

Quick Facts:

- Set Incl. two sides and one back (left, right & back piece)
- 12 gauge heavy duty steel construction

Bench Top Riser - Metal

Width [In]	Depth [In]	Height [In]	Item#
36	10.5	12	E3010
48	10.5	12	E3011
60	10.5	12	E3012
72	10.5	12	E3013
96	10.5	12	E3014

Quick Facts:

- Shelf has built-in rear edge
- Easy to mount to top

Raised Edge - 2 Inch

Item#	Length [In]	Item#	Length [In]
ED2X20	20	ED2X60	60
ED2X30	30	ED2X72	72
ED2X36	36	ED2X96	96
ED2X48	48		

Raised Edge for rear of bench top or shelves. Actual height of edge is 2" and it raises about 3/4" above the top surface.

Raised Edge - 3 Inch

Item#	Length [In]	Item#	Length [In]
ED3X20	20	ED3X60	60
ED3X30	30	ED3X72	72
ED3X36	36	ED3X96	96
ED3X48	48		

Raised Edge for rear of bench top or shelves. Actual height of edge is 3" and it raises about 1 3/4" above the top surface.

Tilt Top - Center Piece

Please Call us for a price quotation. Angle adjustable tops are standard with the Igar System but made to order for each application.

Questions To Ask About Your Project:

- Overall top dimensions?
- Size of top to be tilted (depth and width)
- What is the required angle of the tilt?
- What is the weight on the piece that will tilt?
- What is the product to be worked on?
- Is manual/mechanical, hand crank or motorized adjustment needed?
- Is a front edge required? How high above the top?

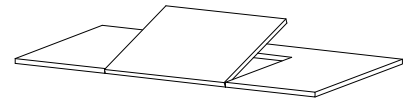

Any part of a bench top can be tilted.

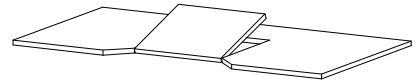

The recessed front accommodates access to parts and tools.

Custom Table Tops

Igar is your complete source for custom tops!

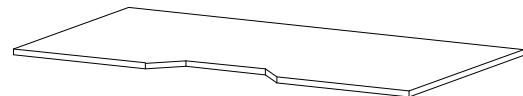
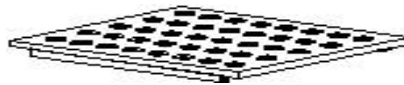
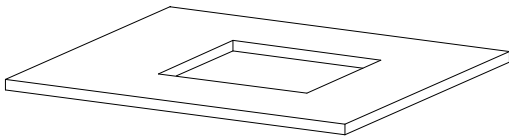

- Maple Tops
- Stainless Steel Tops
- Laboratory Tops
- Roller Ball Tops
- Pneumatic Pop-Up Ball Tops
- UHMW and HDPE Tops
- *Call with your specs!*

Side Shelf for E600 Leg Supports

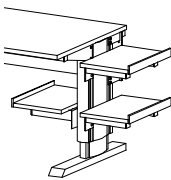

Side shelf available in many different sizes and materials. Please contact us about your specific needs.

Read more about side shelving on page 13

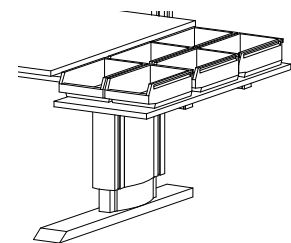

Tops with Recessed Sides for E600 Leg Supports

All Igar tops can be ordered with a recessed sides to accommodate a table top that can be set as low as 16" above the floor level. The top is manually "set" at a starting point and then adjusted up or down with either 16" or 20" motorized stroke. You are guaranteed a truly ergonomic work bench that fits 100% of the population - sitting or standing!

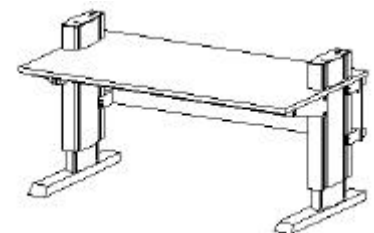

Recessed tops are optional for the E600 leg supports only.

Leg Support Overview

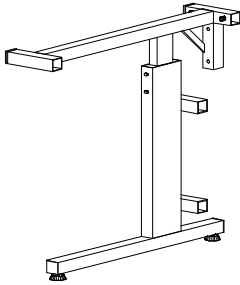

Standard Cantilever

Versions:

- Manual/mechanical
- Hand Crank
- Motorized

See page 7-8

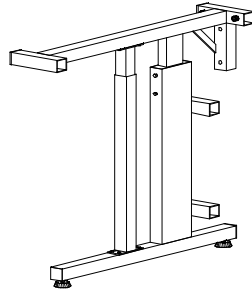

Heavy Duty Cantilever

Versions:

- Hand Crank
- Motorized

See page 8-9

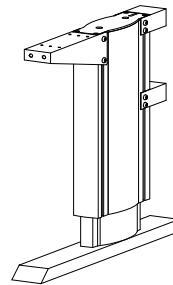

E-600

Versions:

- Motorized

See page 5

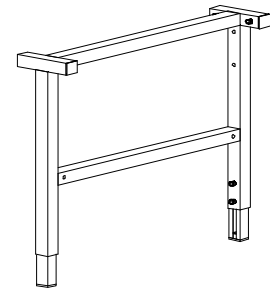

H-support leg

Versions:

- Manual/mechanical
- Hand Crank
- Motorized

See page 6-7

E600 Leg Supports

Item	Number of Legs in Set	Weight Capacity [Lbs]	Stroke Range [In]	Adjustment Range [In]
E55124070US	2	600	15.75	16 to 42.3
E55134070US	3	600	15.75	16 to 42.3
E55144070US	4	600	15.75	16 to 42.3
E55125070US	2	600	19.7	16 to 45.9
E55135070US	3	600	19.7	16 to 45.9
E55145070US	4	600	19.7	16 to 45.9

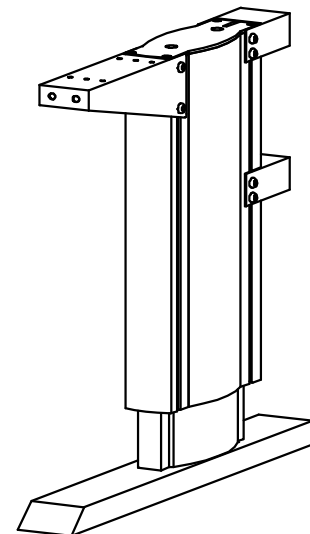

Anodized Aluminum Finish with colored side panels

Quick Facts:

- Electronic Synchronization
- 16 second height adjustment
- Extremely stable & solid leg
- Actuators built-in to leg

More Advantages:

- Leg support has built in "T" slots
- Available with 20" stroke
- Rock solid leg - simply the best!
- Very nice design & quality
- Change colored side inserts

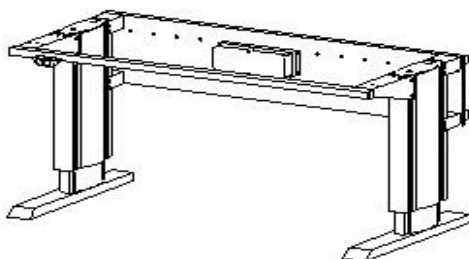

No obstructions between legs

Available Options:

- 1000 Lbs Capacity
- Synchronize up to 4 legs
- Foot pedal or hand held control
- Programable Memory Settings
- Battery back-up system

When the E600 leg supports are combined with a recessed top the bench surface can be manually lowered to as low as 16" above the floor!

Through this very cost effective design the E600 bench can be made to fit virtually any person - regardless of their height.

E600 + 100% Sit-stand = True

H-Support Legs - Mechanical

Mechanical Legs sold in quantities of ONE Each				
Item#	Unit Of Measure	Fits Table top Depth [In]	Adjustment Type	Height Range Low/High
9101L	Each	24 - 28	Allen Wrench	26 - 37
9102L	Each	28 - 32	Allen Wrench	26 - 37
9103L	Each	32 - 36	Allen Wrench	26 - 37
9109L	Each	36 - 72	Allen Wrench	26 - 37

* Add for table top thickness - not incl. in this dimension

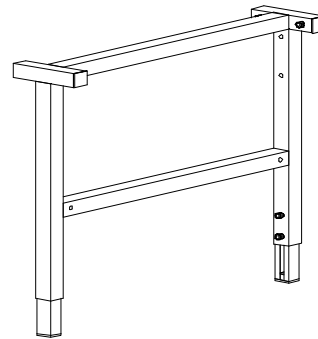

Quick Facts:

- Connect an infinite number of legs in a series
- Very stable & solid leg support
- 900 Lbs. capacity
- Step less manual/ mechanical height adjustment.
- 14 gauge tubular welded construction
- Beige scratch resistant "orange peel" powder coat paint

H-support legs - Hand Crank

Set of 2 legs - Hand Crank				
Item#	Fits Table top Depth [In]	Height Range Low/High	Number of Legs in Set	Stroke [In]
9121L	24 - 27.5	25.75 - 37.50	3	11.75
9122L	28 - 31.5	25.75 - 37.50	3	11.75
9123L	32 - 36	25.75 - 37.50	3	11.75
9129L	36 - 72	25.75 - 37.50	3	11.75

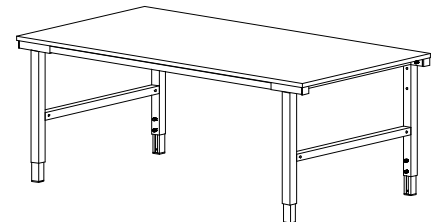

Bench with H-support legs

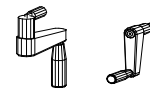

Hand crank folds out of the way

Set of 3 legs - Hand Crank				
Item#	Fits Table top Depth [In]	Height Range Low/High	Number of Legs in Set	Stroke [In]
9131L	24 - 27.5	25.75 - 37.50	3	11.75
9132L	28 - 31.5	25.75 - 37.50	3	11.75
9133L	32 - 36	25.75 - 37.50	3	11.75
9139L	36 - 72	25.75 - 37.50	3	11.75

* Add for table top thickness - not incl. in this dimension

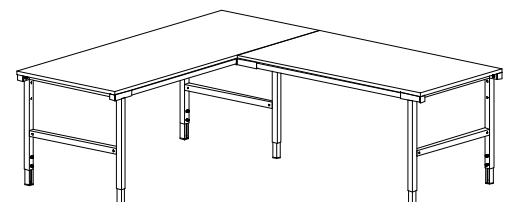

3 legs with hand crank adjustment

Quick Facts - Hand Crank

- Very easy to crank
- Crank folds underneath top when not in use
- 11.75 adjustment stroke
- Std 900 lbs capacity
- Adjusts from 25.75" to 37.50" inches
- Powder coated

H-Leg with Electric Motor

Set of 2 legs - Motorized				
Item#	Fits Table top Depth [In]	Height Range Low/High	Number of Legs in Set	Stroke [In]
9141L	24 - 27.5	25.75 - 37.50	2	11.75
9142L	28 - 31.5	25.75 - 37.50	2	11.75
9143L	32 - 36	25.75 - 37.50	2	11.75
9149L	36 - 72	25.75 - 37.50	2	11.75

Set of 3 legs - Motorized				
Item#	Fits Table top Depth [In]	Height Range Low/High	Number of Legs in Set	Stroke [In]
9151L	24 - 27.5	25.75 - 37.50	3	11.75
9152L	28 - 31.5	25.75 - 37.50	3	11.75
9153L	32 - 36	25.75 - 37.50	3	11.75
9159L	36 - 72	25.75 - 37.50	3	11.75

* Add for table top thickness - not incl. in this dimension

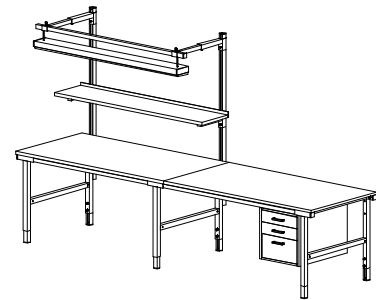
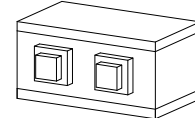
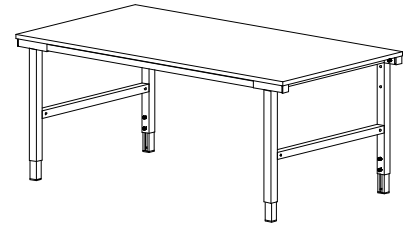

This leg combination is available with electric motor height adjustment

Quick Facts - Motorized

- Standard push button control
- 110 Volt "Plug-n-play"
- No hard wiring required
- Quiet operation
- Use legs to make bench 30" to 16'
- Very stable & solid leg support

L-support legs - Manual/mechanical

Mechanical Legs are sold in quantities of one				
Item#	Fits Table top Depth [In]	Height Range Low/High	UM	Stroke [In]
9107L	24 - 27.5	27 - 38.5	Each	11.5
9108L	28 - 36	27 - 38.5	Each	11.5

* Add for table top thickness - not incl. in this dimension

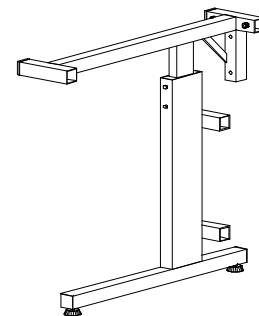

Quick Facts:

- 15.75 adjustment stroke
- 12 & 14 gauge tubular steel
- Welded construction
- Scratch resistant powder coating
- 500 lbs capacity
- Step less manual/ mechanical height adjustment.
- Adjustable feet
- Beige scratch resistant "orange peel" powder coat paint
- Adjusts from 27" to 42.75" in.
- Also available with casters - See page 10

L-support legs - Hand Crank

Set of 2 or 3 legs - Hand Crank				
Item#	Fits Table Top Depth	Number of Legs in Set	Height Range Low/High	Stroke [In]
9127400L	32 - 36	2	27 - 42.75	15.75
9128400L	28 - 32	2	27 - 42.75	15.75
9137400L	32 - 36	3	27 - 42.75	15.75
9138400L	28 - 32	3	27 - 42.75	15.75

Quick Facts:

- Tension adjustable roller bearings.
- 12 & 14 gauge tubular steel
- 15.75 adjustment stroke
- Foldable hand crank
- Very easy to crank
- 500 lbs capacity

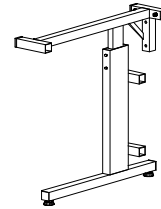

Standard Cantilever Support Leg

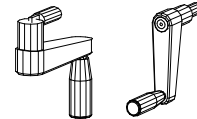

L-support legs - Motorized

Set of 2 or 3 legs - Motorized				
Item#	Fits Table Top Depth	Number of Legs in Set	Height Range Low/High	Stroke [In]
9147400L	32 - 36	2	27 - 42.75	15.75
9148400L	28 - 32	2	27 - 42.75	15.75
9157400L	32 - 36	3	27 - 42.75	15.75
9158400L	28 - 32	3	27 - 42.75	15.75

Quick Facts:

- Tension adjustable roller bearings.
- Standard push button control
- 110 Volt "Plug-n-play"
- No hard wiring required
- Quiet operation
- 500 lbs capacity

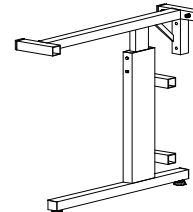
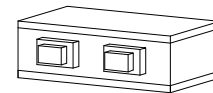

Motorized Cantilever Support Leg

L-support legs - HEAVY DUTY - Hand Crank

Set of 2 or 3 legs - Hand Crank				
Item#	Fits Table Top Depth	Number of Legs in Set	Height Range Low/High	Stroke [In]
9127404L	32 - 36	2	27 - 42.75	15.75
9128404L	28 - 32	2	27 - 42.75	15.75
9137404L	32 - 36	3	27 - 42.75	15.75
9138404L	28 - 32	3	27 - 42.75	15.75

Quick Facts:

- Welded construction
- 15.75 adjustment stroke
- 12 & 14 gauge tubular steel
- 900 lbs capacity
- Adjusts from 27" to 42.75" in.
- Foldable hand crank - easy to crank!

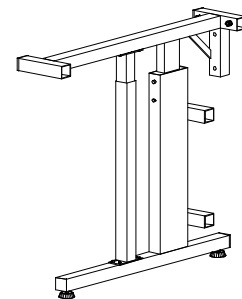

Heavy Duty Cantilever Support Leg

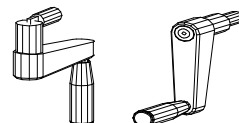

L-support legs - HEAVY DUTY - Motorized

Set of 2 or 3 legs - Motorized				
Item#	Fits Table Top Depth	Number of Legs in Set	Height Range Low/High	Stroke [In]
9147404L	32 - 36	2	27 - 42.75	15.75
914840L	28 - 32	2	27 - 42.75	15.75
9157404L	32 - 36	3	27 - 42.75	15.75
9158404L	28 - 32	3	27 - 42.75	15.75

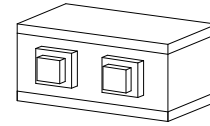

Quick Facts:

- Very stable and solid leg support.
- Quiet operation
- 110 Volt "Plug-n-play"
- No hard wiring required
- 900 lbs capacity
- Standard push button control

Kit for Bench Tops

Bench Top Kits include everything you need to connect the leg supports together. Kit length corresponds to the length (left to right) of the bench tops. Each kit includes hardware, end caps, etc.

Kit for E600 bench *(Note: these kits only fit the E600 leg supports!)*

Top Width [In]	Kit for standard top	Kit for angle adjustable top
	Item#	Item#
36"	EST090A	EMON090A
48"	EST120A	EMON120A
60"	EST150A	EMON150A
72"	EST180A	EMON180A
84"	EST200A	EMON200A
96"	EST240A	EMON240A

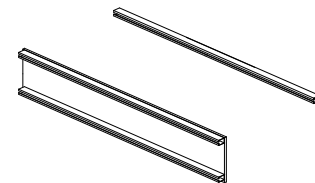

Std. kit Incl. backboard & front track

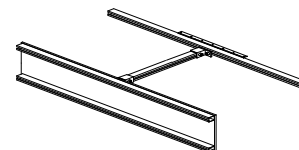

Kit for angle adjustable top includes cross brace and hinged front track

Choose a kit to match the width of the bench top. One (1) kit required for each bench with two leg supports.

Kit for L-support Legs *(Note: these fits both std. and the Heavy Duty models).*

Top Width [In]	Kit for standard top	Kit for angle adjustable top
	Item#	Item#
36"	LST090A	LMON090A
48"	LST120A	LMON120A
60"	LST150A	LMON150A
72"	LST180A	LMON180A
84"	LST200A	LMON200A
96"	LST240A	LMON240A

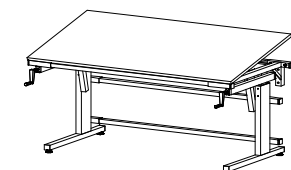
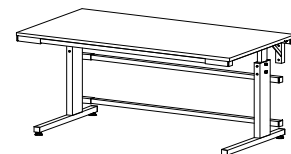

Kit for H-support legs *(These kits are for H-legs ONLY!)*

Top Width [In]	Kit for standard top	Kit for angle adjustable top
	Item#	Item#
36"	HST090A	HMON090A
48"	HST120A	HMON120A
60"	HST150A	HMON150A
72"	HST180A	HMON180A
84"	HST200A	HMON200A
96"	HST240A	HMON240A

* For tops longer than 96" use 3 legs with the appropriate track length.

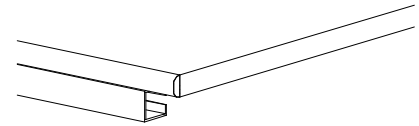

The bench top track included with each kit run underneath the bench top in-between the legs. The bench top mounts to track. A bench with tracks provide a more stable work surface!

- When ordering bench top kits for angle adjustable tops please include information as to what part of the top (if not the whole top) will be adjusted.
- The tracks listed above are standard tracks to fit the most common assembly operations. For heavy duty operations or steep tilt angles please contact us.

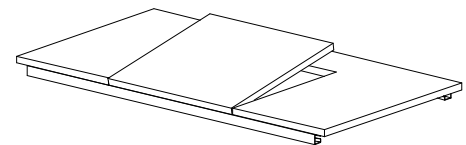

Kit for angle adjustable table top

Tilt of Bench Top

Every bench top can be tilted using standard parts.

Tilt Function for Bench Top: Center piece, partial or all of top

Item#	Adjustment Type Description	Weight on top [Lbs]	Speed [Seconds]	Tilt Angle [Degrees]
-	Manual/Mechanical	-	-	-
-	Hand Crank	-	-	-
-	Motorized	-	-	-

Please let us know some basic information about your project in order to provide accurate and cost-effective pricing.

Casters

Igar offers a wide variety of casters. Only a portion of available casters are shown here.

Casters

Item#	Description	Wheel		Height Added To Bench	Weight Capacity Each
		Swivel Lock	Turning Lock		
9199L	Basic Caster	Yes	Yes	5 in	100 Lbs
CASTER9	Heavy Duty	Yes	Yes	5 in	300 Lbs
2511	Dual wheel	Yes	Yes	4 In	300 Lbs

Item#	Description
9199	Leg extension - For manual H-legs only



Leg Extender

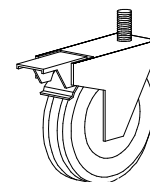

Castor

Shelving

The Igar System features a extensive range of laminated and metal shelving. If you can't find what you need to meet your need in our standard program please contact us with your specifications.

Laminate Shelving & Accessories

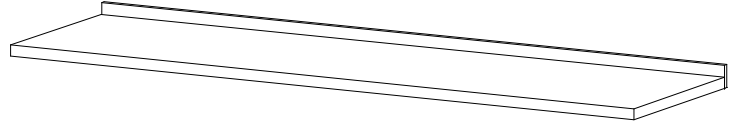

Note: Shelf packaged with brackets and hardware!

Putty Laminate Item#	Grey Laminate Item#	Depth [In]	Length [In]
SP1220A	SG1220A	12	20
SP1230A	SG1230A	12	30
SP1236A	SG1236A	12	36
SP1248A	SG1248A	12	48
SP1260A	SG1260A	12	60
SP1272A	SG1272A	12	72
SP1296A	SG1296A	12	96
SP1520A	SG1520A	15	20
SP1530A	SG1530A	15	30
SP1536A	SG1536A	15	36
SP1548A	SG1548A	15	48
SP1560A	SG1560A	15	60
SP1572A	SG1572A	15	72
SP1596A	SG1596A	15	96

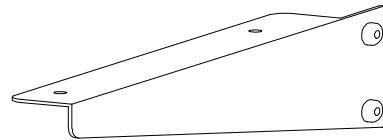

Mount shelf level or at an angle using the Igar multi purpose shelf brackets.

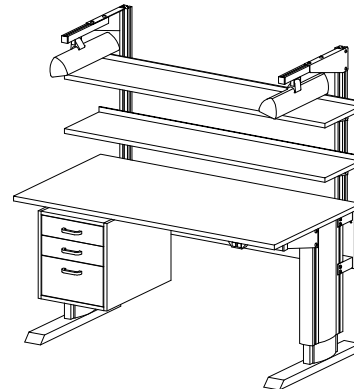

Quick Facts:

- All shelves 1.25" thick
- Industrial grade laminate surface
- Core of high density particle board
- Backer sheet - no exposed wood!
- Multi purpose brackets for level or angled shelves
- All shelves 60" or longer include a support brace - no sagging!
- Can mount backward or forwards on bench.
- Easy to retrofit.

Raised Edge

Item#	Length [In]	Item#	Length [In]
ED2X20	20	ED2X60	60
ED2X30	30	ED2X72	72
ED2X36	36	ED2X96	96
ED2X48	48		

Raised Edge for rear of bench top or shelves. Actual height of edge is 2" and it raises about 3/4" above the shelf surface.

Hoops for shelves

Item#	Description
9614	Wire Hoop for shelf

Note: Price includes installation on shelf

Metal wire hoops are 11" deep and 12" tall.

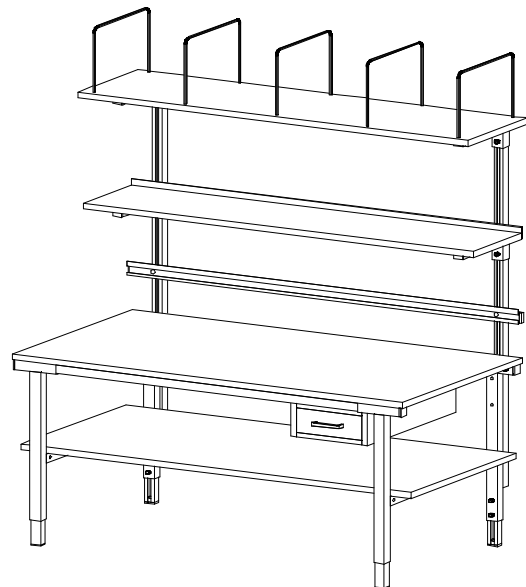

Lower shelf rests on cross braces

Lower shelf (For H-Support leg only!)

Putty Laminate Item#	Grey Laminate Item#	Depth [In]	Length [In]
SP1936A	SG1936A	19.5	36
SP1948A	SG1948A	19.5	48
SP1960A	SG1960A	19.5	60
SP1972A	SG1972A	19.5	72
SP1996A	SG1996A	19.5	96

SP2336A	SG2336A	23.5	36
SP2348A	SG2348A	23.5	48
SP2360A	SG2360A	23.5	60
SP2372A	SG2372A	23.5	72
SP2396A	SG2396A	23.5	96

SP2736A	SG2736A	27.5	36
SP2748A	SG2748A	27.5	48
SP2760A	SG2760A	27.5	60
SP2772A	SG2772A	27.5	72
SP2796A	SG2796A	27.5	96

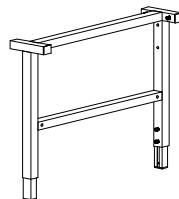

These lower shelves are configured to be mounted on benches that use the H-type support legs. Please contact us for "under the top" shelving for the E600 leg supports.

Metal Shelving

Item	Dimensions		Angle Adjustable	Depth Adjustable
	Depth	Width		
5617	19.5	14.75	Yes	Yes
5618	19.5	32	Yes	Yes
5619	12	14.75	Yes	Yes
5620	12	32	Yes	Yes

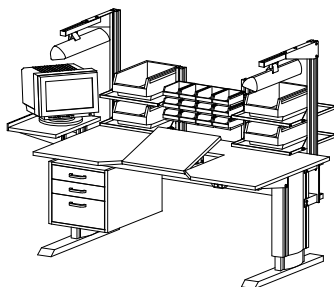

Metal Shelves for plastic bins, test equipment, monitors, etc. Angle adjustable to +/- 25°

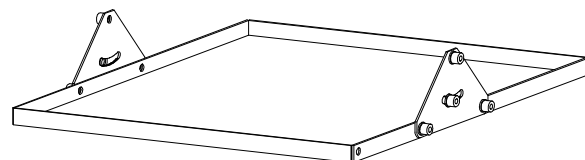

Quick Facts:

- Powder coated "orange peel" surface
- Heavy Duty 16 gage sheet metal
- Depth, Height and Angle Adjustable

Shelving for E600 leg supports (only)

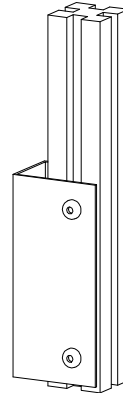
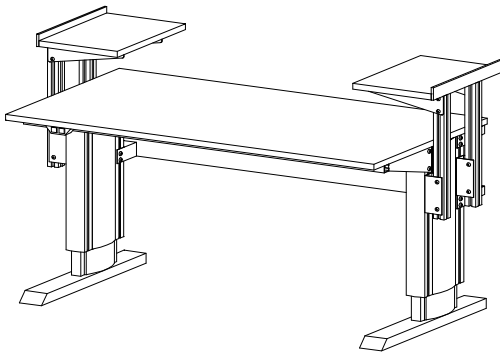

Each Shelf is mounted to the leg support with a bracket as shown to the left. The maximum height of the shelf is determined by the height of the vertical post.

Shelf on 2 vertical post - Height and angle adjustable

Complete kit with a shelf & brackets and upright posts

Post Height	Shelf Dimension		Laminate Color	
	Depth	Width	Putty Item#	Grey Item#
20" 30"	20"	12"	SP2012E SP2012G	SG2012E SG2012G
20" 30"	20"	15"	SP2015E SP2015G	SG2015E SG2015G
20" 30"	30"	12"	SP3012E SP3012G	SG3012E SG3012G
20" 30"	30"	15"	SP3015E SP3015G	SG3015E SG3015G

Quick Facts - Shelving:

- All shelves 1.25" thick
- Industrial grade laminate surface
- Core of high density particle board

Quick Facts - Ergonomics

- Shelving can be level or angled
- Shelf is height adjustable

Note: Raised edge not included. See page 3

Side mounted shelf - Height adjustable

Complete kit with a shelf and shelf brackets

Shelf Dimension	Laminate Color			
	Depth	Width	Putty Item#	Grey Item#
20" 30" 36"	12"		SP2012H	SG2012H
			SP3012H	SG3012H
			SP3012H	SG3612H
20" 30" 36"	15"		SP2015H	SG2015H
			SP3015H	SG3015H
			SP3615H	SG3615H

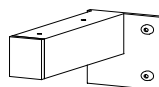

Shelf can be mounted on both inside and outside on the leg.

Shelf is height adjustable

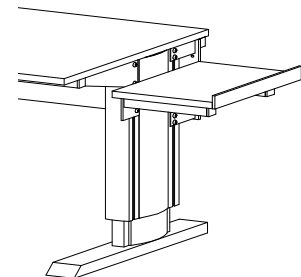

Note: Raised edge not included. See page 12

Quick Facts - Shelving:

- All shelves 1.25" thick
- Industrial grade laminate surface
- Core of high density particle board

Quick Facts - Ergonomics

- Use shelf to hold plastic bins, testing equipment, etc.
- Shelf is height adjustable
- Shelf mounts on the inside of the leg also!

Vertical Uprights & Posts

Use our heavy duty extruded aluminum posts to configure a bench!

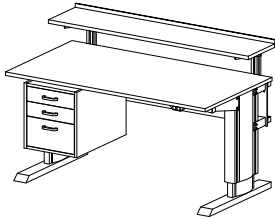

60" wide bench with two 30" long posts

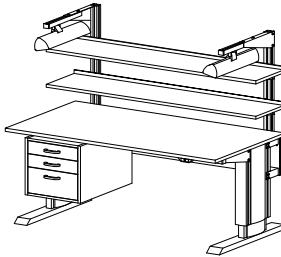

60" wide bench with two 60" long posts

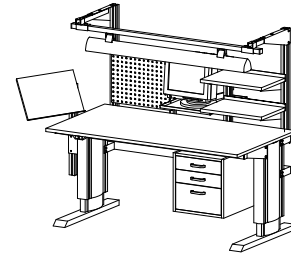

60" wide bench with two 60" long posts and two 30" long posts in the middle.

Posts

Total Post Length [In]	Item#
10"	E56250
20"	E56500
30"	E56750
40"	E561000
60"	E561500

Call For Custom Length Posts!

Quick Facts - Posts:

- 1.75" x 1.75" aluminum construction
- Strong & Durable
- Easy to add on other accessories
- Mount accessories from all four sides of the post!

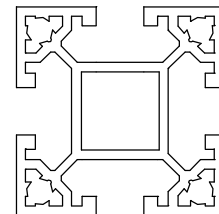

- Easy to use
- Easy to customize
- Easy to integrate with equipment & conveyors

Post Support Tracks *(For "H" and "L" type legs only!)*

Bench Top Width [In]	Item#
48	ST1200A
60	ST1500A
72	ST1800A
96	ST2400A

Post support track provides support for the middle posts.

E600 Bench

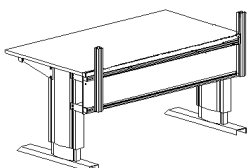

Not Required!
The E600 bench have built in Post Support Tracks.

H-Support Bench

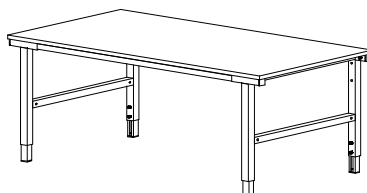

You need Post Support Tracks when ordering one or more middle post!

L-support Bench

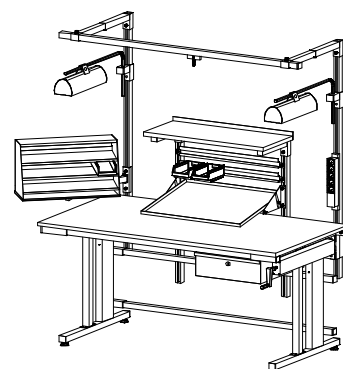

You need Post Support Tracks when ordering one or more middle post!

Overhead Support Arms & Tracks

Use When Mounting Tool Tracks & Light Fixtures

Support Arm - Heavy Duty

Heavy Duty Support Arm	Item#
Set of 2 (Pair)	E5684

Quick Facts - Heavy Duty Arm:

- Height Adjustable
- Depth Adjustable
- Heavy Duty

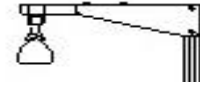
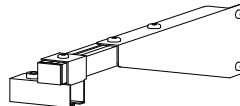

Igar Recommendation: Use when a bench needs both a light fixture and tool track with trolley

Heavy Duty Support Arm

Support Arm - Light Duty

Light Duty Support Arm	Item#
Set of 2 (Pair)	E5684-LP

Quick Facts - Light Duty Arm

- Height Adjustable
- Basic

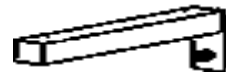

Light Duty Support Arm

Igar Recommendation: Use when a bench needs either a light fixture or a tool track (if both are needed use Item# E5684, above)

Overhead Support Track Kit

Length Of Track	Item#
36"	56090A
48"	56120A
60"	56150A
72"	56180A
84"	56213A
96"	56244A

Quick Facts - Support Track

- 16 gage tubular steel
- Powder coated (orange peel surface)
- End Caps are included
- Track is depth adjustable

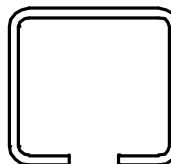
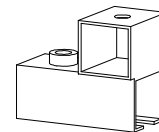
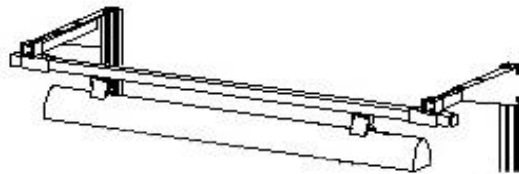

Overhead Support Track for mounting of light fixtures, tool trolleys and tool balancers above the work surface.

Each Kit Includes:

- 1 Ea. Track
- 1 Set of Connectors (2 pieces)

Tool Trolley & Tool Balancers

Tool Trolley

Description	Item#
1-hook trolley	9910

Tool trolley with hook for tools or tool balancers. Fits all overhead support tracks. Roller bearings. (Incl. stop screws - set of 2).

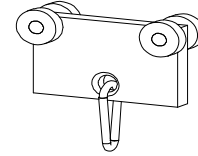

Tool Balancer - Basic Zero Gravity

Item#	Capacity [Lbs]	Cable Length
E4110	1.1 to 3.3	18"
E4111	1.1 to 3.4	39
E4112	2.2 to 6.6	51
E4113	5.5 to 11	51

Quick Facts - Basic Zero-Gravity

- True "Zero-Gravity" balancer
- 360° upper swivel
- 3.3 Ft stranded steel cable
- Tool clip included

Please Call for Higher Capacity Balancers!

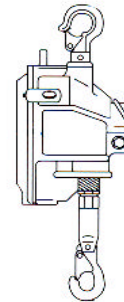

Tool Balancer - Advanced Zero Gravity

Item#	Capacity Range [Lbs]	Cable Length	Stroke [In]	Weight [Lbs]
E4114	1.1 to 3.3	4.26 Feet	51.1"	1.5
E4115	3.3 to 6.6	7.2 Feet	86.4"	3.0
E4116	5.5 to 11	7.2 Feet	86.4"	3.0

Note: Add \$5.79 each for a CLEAR PLASTIC "See through" cover for item# E4114

Quick Facts - Advanced Zero-Gravity Tool Balancer

- Stainless Steel Cable
- Clear plastic see through case
- Ergonomically released spring release
- Enhanced Gear mechanism
- Compact Design
- Adjustable cable stops

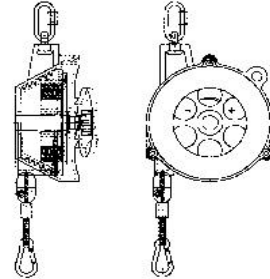

Tool Balancer - Retractor Type (Basic)

Item#	Capacity Range [Lbs]
E4117	0.5 to 1.5
E4118	1.5 to 3.0
E4119	3.0 to 5.0

Quick Facts - Retractor Type

- No tools needed to set tension
- Lightweight and compact
- Adjustable Cable Stop

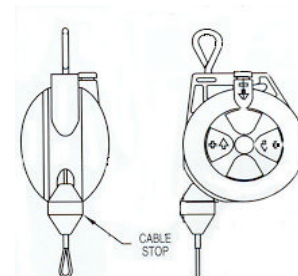

The basic retractable tool balancer is an inexpensive, non-repairable, unit that is easy to use and to adjust (no tools required).

Accessories

Louvered Panel

Description	Dimension L x H [In]	Item#
Louvered Panel - small	27 1/2 x 18	E5654
Louvered Panel - large	34 1/2 x 18	E5655

Quick Facts:

- Bolts to bench uprights
- Accomodates standard bins

Track for Plastic Bins - Short

Description	Mounting Option	Width	Item#
Simple track	Bench	18.5"	E5644
Simple track - Incl. swing arm	Arm	18.5"	E5644A
Allows for 15° angle of bin on one side and a level bin on the other side	Bench	18.5"	E5645
Kit to mount extra tracks to arm	On #E5645	18.5"	E5649

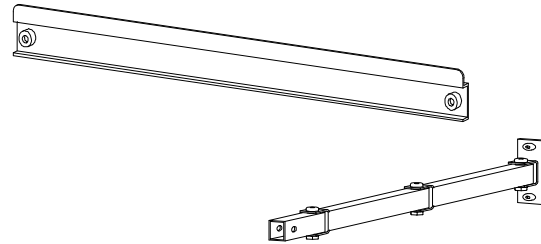

Bin track can be mounted on a swinging arm.

Item# 5644S includes the swinging arm!

Quick Facts:

- Tracks mounted on swinging arms are angle adjustable
- Solid 16 gauge sheet metal construction
- Powder coated

Track for Plastic Bins - Long

Description	Dimensions	Item#
Track for plastic bins	For top 36"	EBT36
	For top 48"	EBT48
	For top 60"	EBT60
	For top 72"	EBT72
	For top 96"	EBT96



**Bin Track - Match with table top depth
Track mount in between upright posts!**

Tray mounted on swinging arm

Description	Dimensions	Item#
Tray and swinging arm combination	12" Deep x 17.5 Wide	E5664S

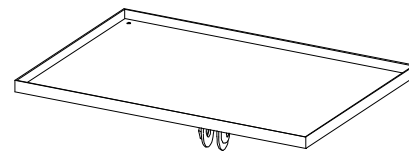

Item# 5664S includes the swinging arm!

Swinging Arm

Description	Dimensions	Item#
Swinging Arm	Length = 22 3/4"	E5660

Quick Facts:

- Three pivot points with individual tension control
- Heavy duty construction

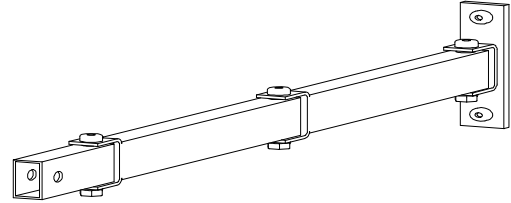

Document Holder on swinging arm

Description	Dimensions	Item#
Document holder - SMALL, arm incl.	Letter size: 9" x 13"	E5668A
Document holder - LARGE, arm incl.	Binder size: 18" x 26"	E5667A

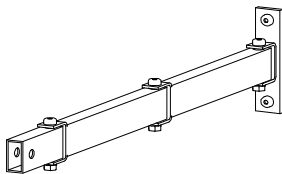

Item# 5644S includes the swinging arm!

- Small: 9" High x 13" Wide
- Large: 18" High x 26" Wide

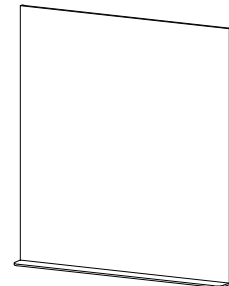

The document holders are available in two sizes!

Monitor Arm - Zero Gravity

Features	Description	Item#
Zero-Gravity	Clamp or post mount	E4074C
Zero-Gravity	Grommet surface mount	E4074G

Heavy Duty Monitor Arm. Well suited for the industrial environment. Great quality and function. Great "Zero-Gravity" Value!



Quick Facts:

- Zero-Gravity "finger tip" adjustment
- Wire rack Keyboard holder
- Backwards - Forward Adjustability
- 360° swivel
- For VDU:s 17" or 70 lbs
- Clamp or post mount

Monitor Arm - Adjustable (Basic)

Features	Description	Item#
Adjustable	Clamp mount	E4071
Adjustable	Post mount	E4072
Adjustable	Grommet surface mount	E4073

This is a basic heavy duty monitor arm with a lot of adjustability but without the "Zero-Gravity" features.



Quick Facts:

- Backwards - Forward Adjustability
- Wire rack Keyboard holder
- 360° swivel
- For VDU:s 17" or 70 lbs

Keyboard Shelves - Basic

Features	Inside Dimensions D x W x H [In]	Color	Item#
Keyboard Shelf	9 1/8 x 20 3/4 x 1 5/64	Light Grey	E4095

Quick Facts:

- Ball bearing glides
- Fits all standard PC/AT keyboards
- 7/8 extension
- Light gray plastic material

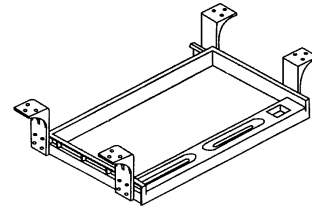

Keyboard Shelf

Features	Inside Dimensions D x W x H [In]	Color	Item#
Keyboard Shelf	10 x 20 .5 x 2.5	Black	E4092

Quick Facts:

- 7 5/8 Height Adjustment
- 30° Forward Tilt
- 10° Backward Tilt
- 30° swivel
- Integrated Wrist Rest
- Attached to any desk with flat bottom

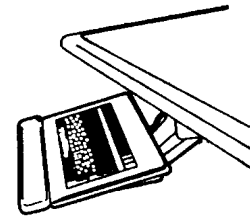

Keyboard Shelf - With Mouse Pad

Features	Inside Dimensions D x W x H [In]	Color	Item#
Keyboard Shelf	10 x 20.5 x 2.5	Black	E4093

Quick Facts:

- As above but including a platform that holds a mouse

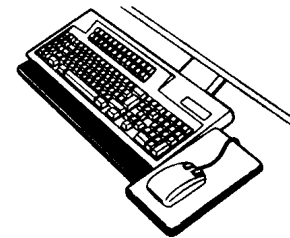

Keyboard Drawer

Features	Inside Dimensions D x W x H [In]	Color	Item#
Keyboard Drawer	12 x 20.5 x Adjustable	Black	E4094
...with Mousetray	12 x 20.5 x Adjustable	Black	E4096

Quick Facts:

- Adjusts in 7 positions from 2.5 to 3.75
- Locks in open position
- Incl. integral adjustable wrist rest

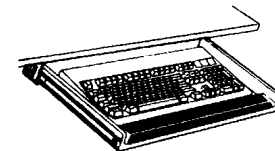

Keyboard & Pencil Drawer

Features	Inside Dimensions D x W x H [In]	Color	Item#
Keyboard Drawer	9 1/8 x 20.5 x 1 57/64	Light Gray	E4097

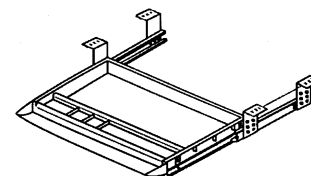

CPU Holder

Features	Color	Item#
CPU Holder	Black	E4081

Quick Facts:

- Heavy Duty Unit
- Mounts under top
- 16" Sliding track - full access!
- 360° rotation

Cable Management

Features	Length	Item#
Cable Duct	36"	E4040
Cable Duct	48"	E4041
Cable Duct	60"	E4042
Cable Duct	72"	E4043
Cable Duct	96"	E4045

Quick Facts:

- Mounts at rear of top
- Match length of duct with table top width
- 1.75 x 1.75 aluminum tubing with removable top
- Easy to customize

Other cable management solutions are also available!

Electric Outlet Strips

No. of Outlets	Fixture Length	Item#
4	10"	EL0410
6	12"	EL0612
8	13"	EL0813
7	24"	EL0824
8	48"	EL0848
9	48"	EL1648
10	72"	EL1272
11	72"	EL2072

Quick Facts:

- Mounts on all four sides of the top
- Mounts on rear of post
- Brackets included
- Aluminum encased
- 15 Amp (call for higher capacity)
- Lighted master switch
- 6 foot cord (call for optional 15' cord)

Plastic Bins

Description	Item#	Dimensions			Carton Quant
		Length	Width	Height	
Std., XL Tall	9071	19 5/8	12 1/8	9 7/8	8
Std., XL Low	9072	19 5/8	12 1/8	7 7/8	8
Std., Large	9073	13 3/4	8 1/8	6	12
Std., Medium	9074	9 7/8	5 7/8	5 1/8	24
Std., Small	9075	6 3/4	4 1/8	3	20
Std., Mini	9076	3 3/4	4 1/8	1 3/4	20

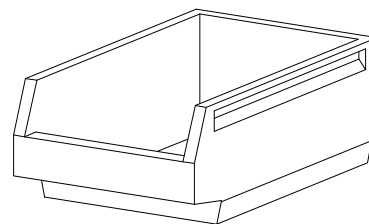

Plastic Bins - ESD

Description	Item#	Dimensions			Carton Quant
		Length	Width	Height	
ESD, Large	9073E	13 3/4	8 1/8	6	12
ESD, Medium	9074E	9 7/8	5 7/8	5 1/8	24
ESD, Small	9075E	6 3/4	4 1/8	3	20
ESD, Mini	9076E	3 3/4	4 1/8	1 3/4	20

Plastic bins are only sold in full carton quantities

Many other sizes and types of bins are also available. Please Call!

Drawers & Cabinets

Laminated Cabinets & Drawers

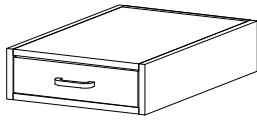

1075

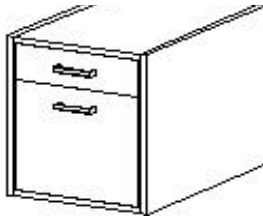

1072CL

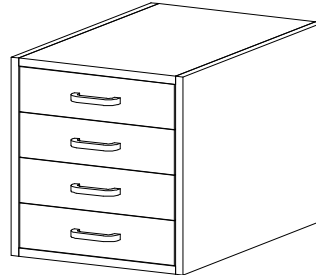

1072AL



1073BL

Description	Dimensions D x W x H	Item per option	
		Hanging	Castors & Top
1 small drawer	22 x 11 x 5 1/2	1075L	N/A
1 small & 1 file drawer	23 x 15 1/2 x 18 1/2	1072CL	1073CL
2 small & 1 large drawer	23 x 15 1/2 x 18 1/2	1072BL	1073BL
4 small drawers	23 x 15 1/2 x 18 1/2	1072AL	1073AL



Brackets are included

Quick Facts:

- All cabinets have central key lock. One key locks all drawers.
- Mounts anywhere underneath the bench top.
- Metal glides
- Add 4" to height for a unit with casters and laminated top.

Metal Drawers - Standard

No. Of Drawers	Dimensions D x W x H			Item#
1	16	15.5	5.5	E1021
2	16	15.5	12.5	E1022
3	16	15.5	18.5	E1023
4	16	15.5	24.5	E1024
1	24	15.5	5.5	E1031
2	24	15.5	12.5	E1032
3	24	15.5	18.5	E1033
4	24	15.5	24.5	E1034
1	24	21.5	5.5	E1035
2	24	21.5	12.5	E1036
3	24	21.5	18.5	E1037
4	24	21.5	24.5	E1038

Quick Facts:

- 16 gage steel
- Ball bearing steel rollers
- Incl. 1" tall sliding tray insert
- Standard cylinder lock
- Standard recessed handle

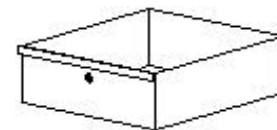

Note: All metal drawer units comes STANDARD with key lock (installed) and a recessed handle. All drawers are available with a padlock tab upon request (deduct \$12.00 for each lock).

Metal Drawers - Heavy Duty

No. Of Drawers	Dimensions D x W x H			Item#
1	24	21.5	5.5	E1041

Quick Facts:

- 14 gage steel
- All other features as standard drawers

Metal Drawers - Stackable

No. Of Drawers	Dimensions D x W x H			Item#
1	16.25	17.75	6.75	E1051
1	24.25	17.75	6.75	E1052
1	24.25	23.25	6.75	E1053

Quick Facts:

- 16 gage steel
- Ball bearing steel rollers
- Incl. 1" tall sliding tray insert
- Standard cylinder lock
- Standard recessed handle

Metal Cabinet

No. Of Doors	Dimensions D x W x H			Item#
1	19	18	19	E1061
2	19	36	19	E1062

Quick Facts:

- 8" shelf clearance
- Standard locking handle with key
- Includes one shelf

Note: All metal drawer units comes STANDARD with key lock (installed) and a recessed handle. All drawers are available with a padlock tab upon request (deduct \$12.00 for each lock).

Peg Boards, Magnet & Privacy Boards

Magnet Board

Dimensions Width x Height		Item#
15.5	20	E1061

Quick Facts:

- Mounts in between upright posts
- Height adjustable
- Powder coated

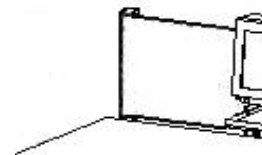

Magnet Board

Peg Board

Dimensions Width x Height		Item#
15.5	20	E1061

Quick Facts:

- Mounts in between upright posts
- Height adjustable
- Upholstered fabric surface

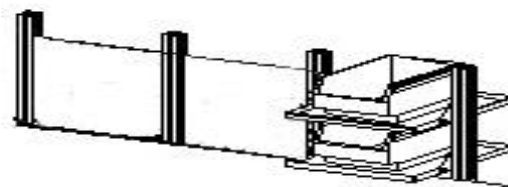

Peg Board

Tool Board

Description	Dimension L x H [In]	Item#
Tool Board - Bench mount	18 ¾ x 14 ¾	E5653
Tool Board - with Swinging Arm	19 ¾ x 14 ¾	E5653A

Quick Facts:

- Tool board metal with perforated square holes.

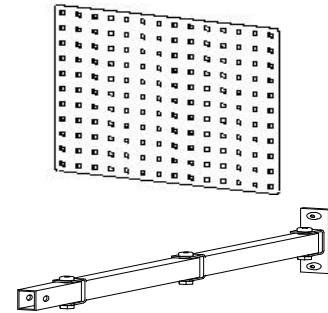

Tool Board can be mounted on a swinging Arm

Hooks for Tool Board

Our new "Euro Style" tool hooks makes hanging and storing tools a snap!

Quick Facts:

- Unique "snap-in" tool hooks
- Very easy to mover around
- No tools required

Type of Hook	Hook Dim.		Item#
	Length [In]	Width [In]	
Single Hook	1.5	N/A	891010
Single	2.5	N/A	891030
Single	3.5	N/A	891050
Angled Hook	3.5	N/A	891100
Double Hook	1	3/8	891150
Double Hook	1 3/8	5/8	891160
Double Hook	1 5/8	15/16	891170
Double Hook	1 7/8	Call	891180
Double Hook	2 3/16	Call	891190
Double Hook	2 1/2	Call	891200
Double Hook Round	Call	3/8	891250
Double Hook Round	Call	5/8	891260
Double Hook Round	Call	15/16	891270
Round Hook - Double	Call	3/8	891300
Round Hook - Double	Call	5/8	891310
Round Hook - Double	Call	15/16	891320
Tool Holder - Clamping	3.5	N/A	891430
Tool Holder - Clamping	4.5	N/A	891450
Tool Holder - Clamping	5.5	N/A	891470
Tool Holder - Round	3.5	N/A	891550
Tool Holder - Round	4.5	N/A	891560
Tool Holder - Round	5.5	N/A	891570
Tool Hook - Round	4.5	N/A	Call
Tool Hook - Round	5.5	N/A	Call
Drill Bit Holder - 21 bits	Call for larger		891700
Drill Bit Holder - 10 bits	holders!		891710
Screw Driver Holder	Holds 32 bits From 1/8" to 9/16"		891780
Shelf for Tool Board	5.5	N/A	891810



Angled Hook



Single Hook



Double Hook



Double Hook Round

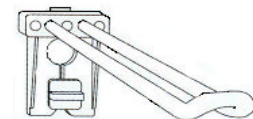

Round Hook - Double



Tool Holder - Clamping



Tool Holder - Round



Drill Bit Holder



Screw Drive Holder



Shelf (small)

Light Fixtures

DUO & Parabol Fixtures

22" LONG DUO

Item	Version	Dimmer Switch?	Number of Bulbs
PA155	Std	No	1
PA155TD	Std	YES	1
PA155TE	ESD	No	1
PA15TDE	ESD	YES	1

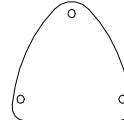

Quick Facts:

- 55 Watt "Dulux-L" bulb (commonly available)
- 12,000 hours of bulb life
- High frequency flicker free light source
- Aluminum extruded casing
- Parabolic "no glare" louver
- Electronic ballast
- "Instant start" fluorescent light
- Angle adjustable by the touch of the hand
- Optional Dimmer Switches
- Optional ESD version

36" LONG DUO

Item	Version	Dimmer Switch?	Number of Bulbs
PA121	Std	No	1
PA121TD	Std	YES	1
PA121TE	ESD	No	1
PA121TDE	ESD	YES	1

Quick Facts:

- Same as above but with a 21 Watt Hi-Output Linear T5 bulb

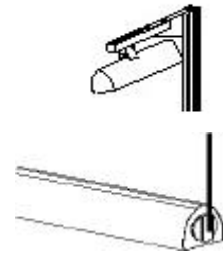

48" LONG PARABOL

Item	Version	Dimmer Switch?	Number of Bulbs
PA154T	Std	No	1
PA154TD	Std	YES	1
PA154TE	ESD	No	1
PA154TDE	EST	YES	1

Quick Facts:

- Same as above but with a 54 Watt Hi-Output Linear T5 bulb



60" LONG PARABOL

Item	Version	Dimmer Switch?	Number of Bulbs
PA180T	Std	No	1
PA180TD	Std	YES	1
PA180TE	ESD	No	1
PA180TDE	ESD	YES	1

Quick Facts:

- Same as above but with a 80 Watt Hi-Output Linear T5 bulb

Note: Other lighting solutions - Including dual and four bulb fixtures are also available - Please Call!